

Triku round table

760 x Ø 800 mm

Design by Samuel Accoceberry

 design Nation



The Triku collection draws inspiration from dolmens (triku harri in Basque), prehistoric structures consisting of a large capstone resting on upright stones. The Triku series, which features simple, ample forms, is crafted out of the most traditional of materials: wood and wool.

CATEGORY:

Table

ENVIRONMENT:

Indoor

APPLICATIONS:

- CHR
- Public
- Office

WEIGHT: 31 kg

MATERIALS:

Structure and legs in solid oak. Table top in multy-ply of massive oak (25 mm + 15 mm).

MADE TO ORDER: Finishes and upholsteries, page 2

ACCESSORIES: No

ASSEMBLED PRODUCT: Yes

REMOVABLE PRODUCT: No

CLEANING AND CARE INSTRUCTIONS:

Dry cloth. To avoid aerosol and spray products with silicone.

DOWNLOADS:

3D and 2D files are available at alki.fr – images bank section.

DIMENSIONS :

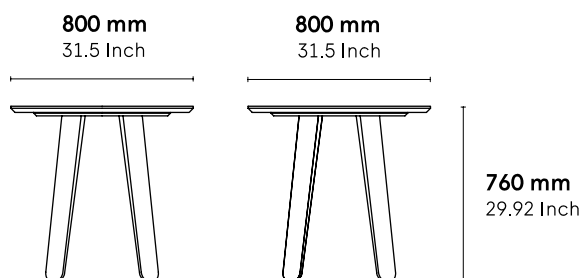

Non contractual document - modifiable without previous notice.

Triku round table

760 x Ø 1000 mm

Design by Samuel Accoceberry

 design Nation



The Triku collection draws inspiration from dolmens (triku harri in Basque), prehistoric structures consisting of a large capstone resting on upright stones. The Triku series, which features simple, ample forms, is crafted out of the most traditional of materials: wood and wool.

CATEGORY:

Table

ENVIRONMENT:

Indoor

APLICATIONS:

- CHR
- Public
- Office

WEIGHT: 33 kg

MATERIALS:

Structure and legs in solid oak. Table top in multy-ply of massive oak (25 mm + 15 mm).

MADE TO ORDER: Finishes and upholsteries, page 2

ACCESSORIES: No

ASSEMBLED PRODUCT: Yes

REMOVABLE PRODUCT: No

CLEANING AND CARE INSTRUCTIONS:

Dry cloth. To avoid aerosol and spray products with silicone.

DOWNLOADS:

3D and 2D files are available at alki.fr – images bank section.

DIMENSIONS :

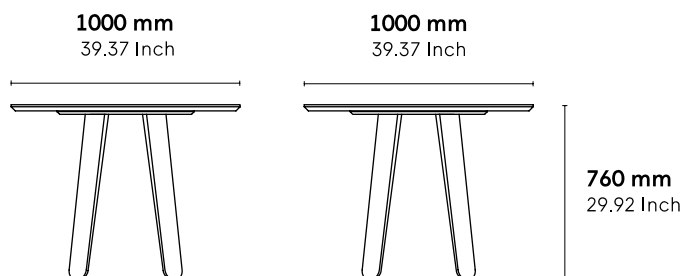

Non contractual document - modifiable without previous notice.

Triku round table

760 x Ø 1200 mm

Design by Samuel Accoceberry



The Triku collection draws inspiration from dolmens (triku harri in Basque), prehistoric structures consisting of a large capstone resting on upright stones. The Triku series, which features simple, ample forms, is crafted out of the most traditional of materials: wood and wool.

CATEGORY:

Table

ENVIRONMENT:

Indoor

APPLICATIONS:

- CHR
- Public
- Office

WEIGHT: 35 kg

MATERIALS:

Structure and legs in solid oak. Table top in multy-ply of massive oak (25 mm + 15 mm).

MADE TO ORDER: Finishes and upholsteries, page 2

ACCESSORIES: No

ASSEMBLED PRODUCT: Yes

REMOVABLE PRODUCT: No

CLEANING AND CARE INSTRUCTIONS:

Dry cloth. To avoid aerosol and spray products with silicone.

DOWNLOADS:

3D and 2D files are available at alki.fr – images bank section.

DIMENSIONS :

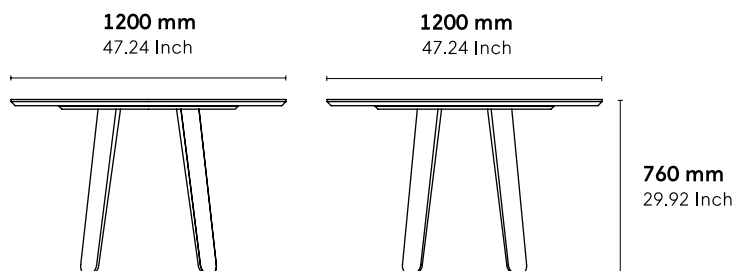

Non contractual document - modifiable without previous notice.

Triku round table

760 x Ø 1400 mm

Design by Samuel Accoceberry

 design Nation



The Triku collection draws inspiration from dolmens (triku harri in Basque), prehistoric structures consisting of a large capstone resting on upright stones. The Triku series, which features simple, ample forms, is crafted out of the most traditional of materials: wood and wool.

CATEGORY:

Table

ENVIRONMENT:

Indoor

APLICATIONS:

- CHR
- Public
- Office

WEIGHT: 37 kg

MATERIALS:

Structure and legs in solid oak. Table top in multy-ply of massive oak (25 mm + 15 mm).

MADE TO ORDER: Finishes and upholsteries, page 2

ACCESSORIES: No

ASSEMBLED PRODUCT: Yes

REMOVABLE PRODUCT: No

CLEANING AND CARE INSTRUCTIONS:

Dry cloth. To avoid aerosol and spray products with silicone.

DOWNLOADS:

3D and 2D files are available at alki.fr – images bank section.

DIMENSIONS :

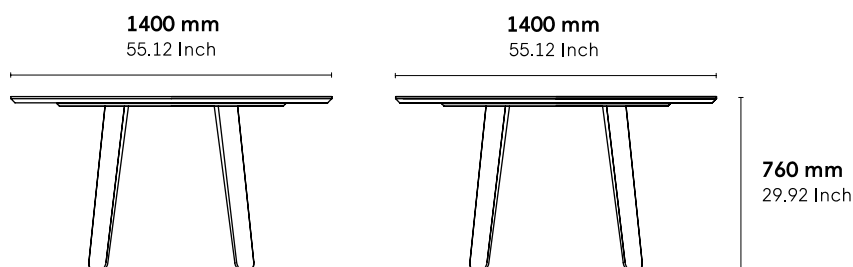

Non contractual document - modifiable without previous notice.

Finishes

Wood



Natural Oak

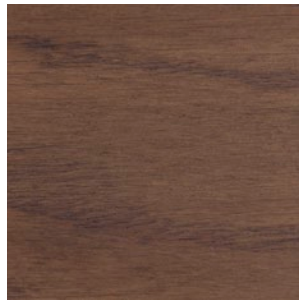

Ash Grey Oak

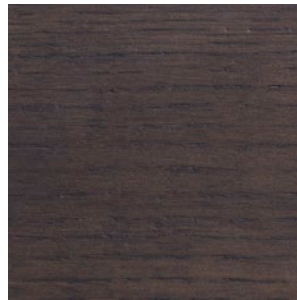

Tourbe Oak



Carbon Oak



Walnut Stained Oak

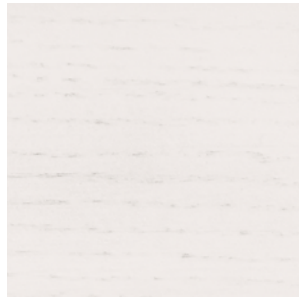

White Stained Oak

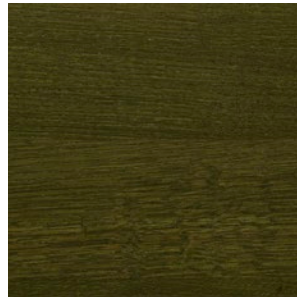

Green 21 Oak Stain



Orange 19 Oak Stain

Triku ovale table

760 x 1800 x 1000 mm

Design by Samuel Accoceberry

 design Nation



The Triku collection draws inspiration from dolmens (triku harri in Basque), prehistoric structures consisting of a large capstone resting on upright stones. The Triku series, which features simple, ample forms, is crafted out of the most traditional of materials: wood and wool.

CATEGORY:

Table

ENVIRONMENT:

Indoor

APPLICATIONS:

- CHR
- Public
- Office

WEIGHT: 45 kg

MATERIALS:

Structure and legs in solid oak. Table top in multy-ply of massive oak (25 mm + 15 mm).

MADE TO ORDER: Finishes and upholsteries, page 2

ACCESSORIES: No

ASSEMBLED PRODUCT: Yes

REMOVABLE PRODUCT: No

CLEANING AND CARE INSTRUCTIONS:

Dry cloth. To avoid aerosol and spray products with silicone.

DOWNLOADS:

3D and 2D files are available at alki.fr – images bank section.

DIMENSIONS :

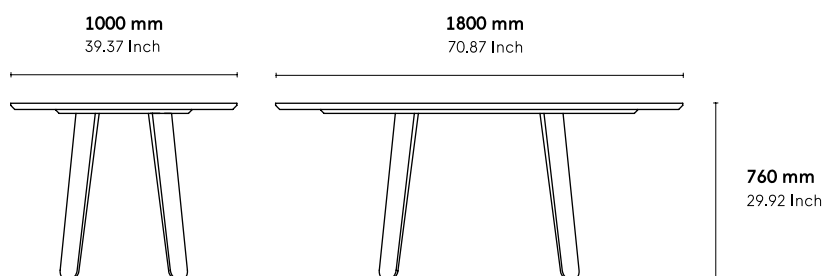

Non contractual document - modifiable without previous notice.

Triku ovale table

760 x 2300 x 1000 mm

Design by Samuel Accoceberry

 design Nation



The Triku collection draws inspiration from dolmens (triku harri in Basque), prehistoric structures consisting of a large capstone resting on upright stones. The Triku series, which features simple, ample forms, is crafted out of the most traditional of materials: wood and wool.

CATEGORY:

Table

ENVIRONMENT:

Indoor

APLICATIONS:

- CHR
- Public
- Office

WEIGHT: 64 kg

MATERIALS:

Structure and legs in solid oak. Table top in multy-ply of massive oak (25 mm + 15 mm).

MADE TO ORDER: Finishes and upholsteries, page 2

ACCESSORIES: No

ASSEMBLED PRODUCT: Yes

REMOVABLE PRODUCT: No

CLEANING AND CARE INSTRUCTIONS:

Dry cloth. To avoid aerosol and spray products with silicone.

DOWNLOADS:

3D and 2D files are available at alki.fr – images bank section.

DIMENSIONS :

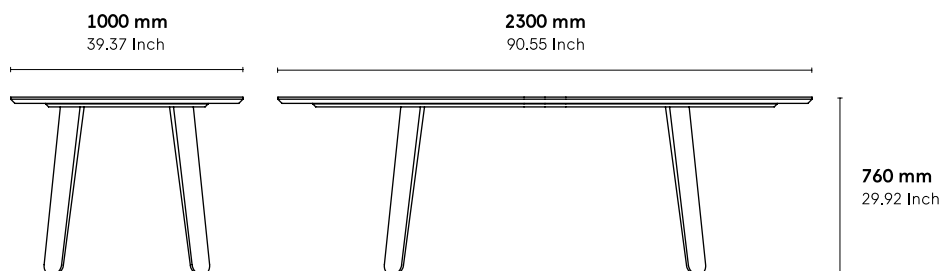

Non contractual document - modifiable without previous notice.

Triku ovale table with extension

760 x 1800/2300 x 1000 mm

Design by Samuel Accoceberry

 design Nation



The Triku collection draws inspiration from dolmens (triku harri in Basque), prehistoric structures consisting of a large capstone resting on upright stones. The Triku series, which features simple, ample forms, is crafted out of the most traditional of materials: wood and wool.

CATEGORY:

Table

ENVIRONMENT:

Indoor

APLICATIONS:

- CHR
- Public
- Office

WEIGHT: 75 kg

MATERIALS:

Structure and legs in solid oak. Table top in multy-ply of massive oak (25 mm + 15 mm).

MADE TO ORDER: Finishes and upholsteries, page 2

ACCESSORIES: No

ASSEMBLED PRODUCT: Yes

REMOVABLE PRODUCT: No

CLEANING AND CARE INSTRUCTIONS:

Dry cloth. To avoid aerosol and spray products with silicone.

DOWNLOADS:

3D and 2D files are available at alki.fr – images bank section.

DIMENSIONS :

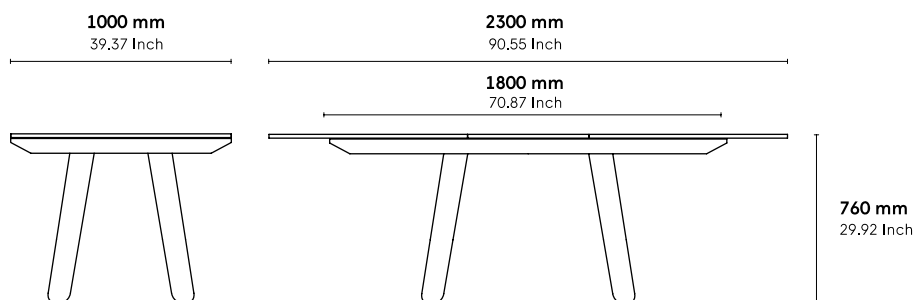

Non contractual document - modifiable without previous notice.

Finishes

Wood



Natural Oak

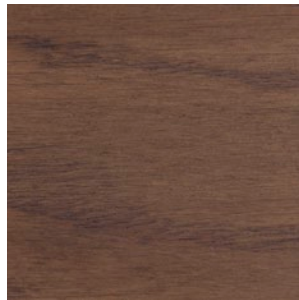

Ash Grey Oak

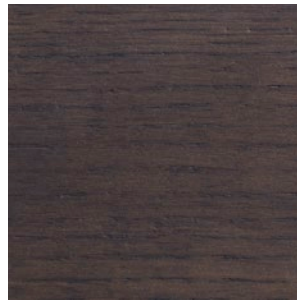

Tourbe Oak



Carbon Oak



Walnut Stained Oak

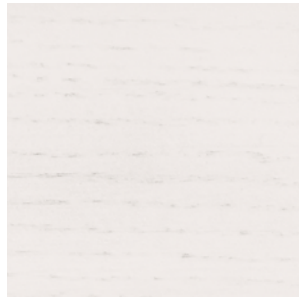

White Stained Oak

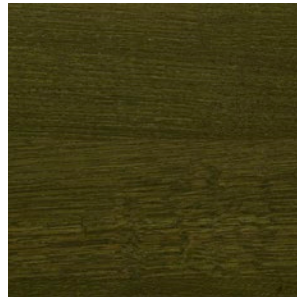

Green Z1 Oak Stain



Orange 19 Oak Stain

Triku ovale table

760 x 1800 x 1000 mm

Design by Samuel Accoceberry

 design Nation



The Triku table has a solid oak structure and top. It is available rounded or oval. The oval version can be extensible.

CATEGORY:

Table

ENVIRONMENT:

Indoor

APPLICATIONS:

- CHR
- Public
- Office

WEIGHT: 45 kg

MATERIALS:

Structure and legs in solid oak. Table top in multy-ply of massive oak (25 mm + 15 mm).

MADE TO ORDER: Finishes and upholsteries, page 2

ACCESSORIES: No

ASSEMBLED PRODUCT: Yes

REMOVABLE PRODUCT: No

CLEANING AND CARE INSTRUCTIONS:

Dry cloth. To avoid aerosol and spray products with silicone.

DOWNLOADS:

3D and 2D files are available at alki.fr – images bank section.

DIMENSIONS :

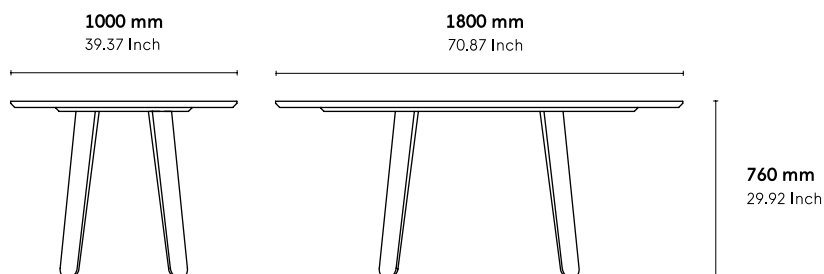

Non contractual document - modifiable without previous notice.

Electrification

Electrification Bachmann



Cable pass system



Triku ovale table

760 x 2300 x 1000 mm

Design by Samuel Accoceberry

 design Nation



The Triku table has a solid oak structure and top. It is available rounded or oval. The oval version can be extensible.

CATEGORY:

Table

ENVIRONMENT:

Indoor

APPLICATIONS:

- CHR
- Public
- Office

WEIGHT: 64 kg

MATERIALS:

Structure and legs in solid oak. Table top in multy-ply of massive oak (25 mm + 15 mm).

MADE TO ORDER: Finishes and upholsteries, page 2

ACCESSORIES: No

ASSEMBLED PRODUCT: Yes

REMOVABLE PRODUCT: No

CLEANING AND CARE INSTRUCTIONS:

Dry cloth. To avoid aerosol and spray products with silicone.

DOWNLOADS:

3D and 2D files are available at alki.fr – images bank section.

DIMENSIONS :

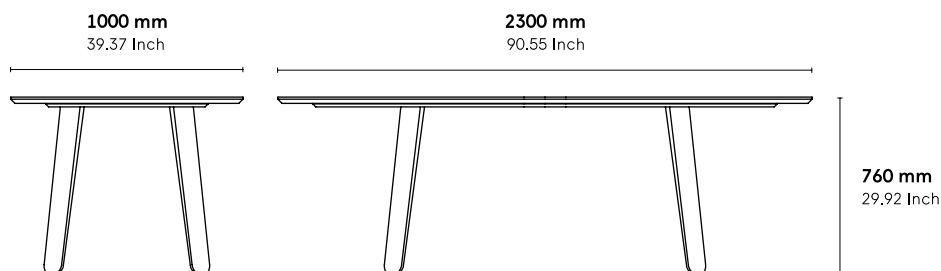

Non contractual document - modifiable without previous notice.

Electrification

Electrification Bachmann



Cable pass system

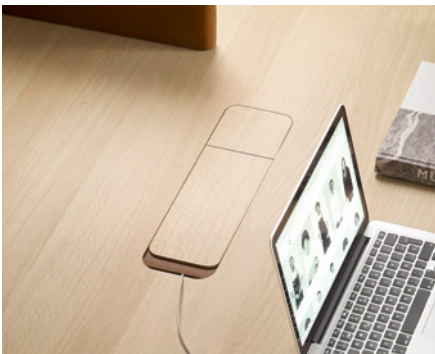

Finishes

Wood



Natural Oak

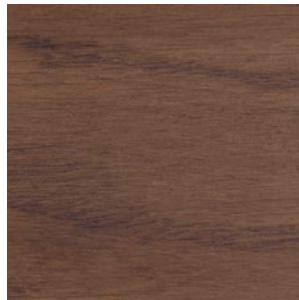

Ash Grey Oak

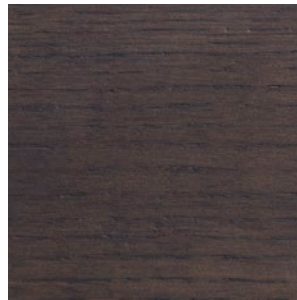

Tourbe Oak



Carbon Oak



Walnut Stained Oak



White Stained Oak

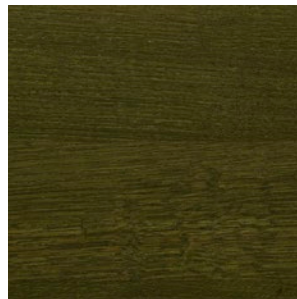

Green Z1 Oak Stain



Orange 19 Oak Stain