



**STOCKHOLM**

TECHNICAL INFORMATION SHEET

# STOCKHOLM

BY MARIO RUIZ, 2013



# design Nation

# punt



reddot design award  
winner 2015



## PRODUCT TYPE

Bedside tables, sideboards, chest drawers, cupboards & desks

The large Stockholm family, consisting of sideboards, cupboards, chests of drawers, bedside tables, tables, coffee tables, desks, lamps and rugs, is characterized by the unique use of aluminum as the material that connects all the pieces. The collection won the Red Dot Award in 2015 and has become a Punt signature icon.

## TIPOLOGÍA DE PRODUCTO

Mesitas de noche, aparadores, cómodas, alacenas y escritorios

La gran familia Stockholm, compuesta por aparadores, alacenas, cómodas, mesitas de noches, mesa, mesas bajas, escritorios, lámparas y alfombras, se caracteriza por el singular uso del aluminio como hilo conductor entre todas las piezas. La colección fue merecedora del premio Red Dot en 2015 y se ha convertido en un icono de la firma Punt.

## DETAILS. DETALLES





## DIMENSIONS BED SIDE TABLES DIMENSIONES MESITAS DE NOCHE

### STH151 Slim

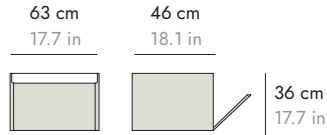
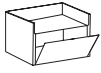

### STH153 Slim + Technic doors

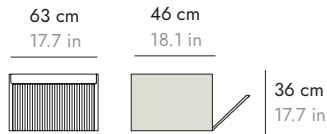
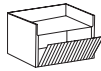

### STH105

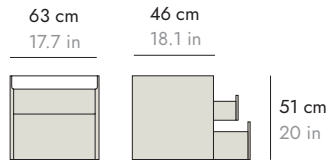
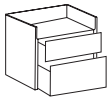

## METAL BASES ZÓCALOS

|  |                      |                       |                                       |
|--|----------------------|-----------------------|---------------------------------------|
|  | <b>H 6 cm - 2.3"</b> | <b>H 17 cm - 6.7"</b> | <b>WALL BRACKET<br/>HERRAJE PARED</b> |
|  | <br>53.5 cm 21 in    | <br>58 cm 22.9 in     |                                       |

## DIMENSIONS SIDEBOARD 122 cm DIMENSIONES APARADORES 122 cm

### STH251 Slim

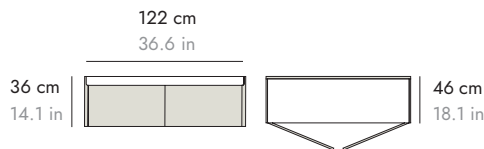
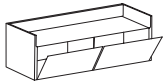

### STH253 Slim + Technic doors

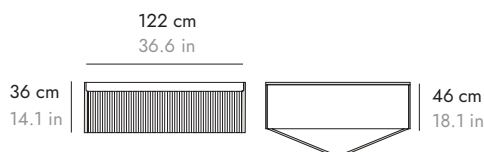
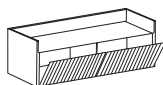



## STH201

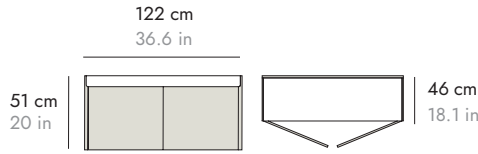
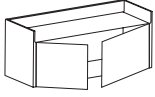

## STH203 Technic doors

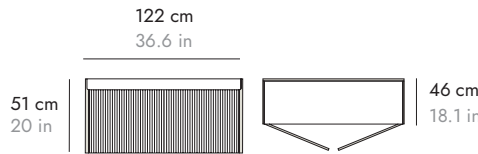
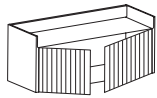

## DIMENSIONS CUPBOARD 122 cm DIMENSIONES ALACENAS 122 cm

## STH224 2 units metal base. Zócalo 2 módulos.

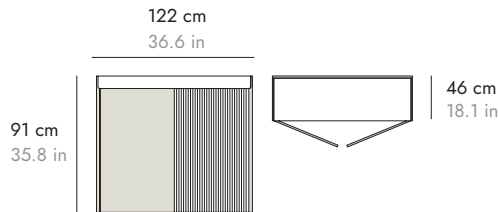
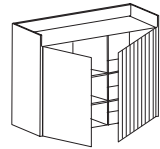

## STH225 Depth for integrated fridge. Profundidad para nevera integrada.

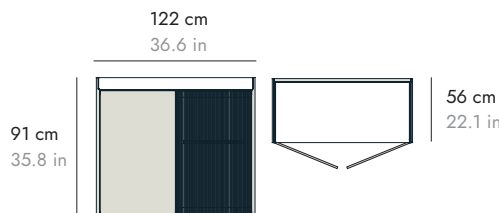
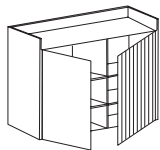

REFERENCE WITH GROMMETS  
REFERENCIA CON PASACABLES

## METAL BASES ZÓCALOS

|  | H 6 cm - 2.3" | H 17 cm - 6.7" | H 29 cm - 11.4" | WALL BRACKET<br>HERRAJE PARED |
|--|---------------|----------------|-----------------|-------------------------------|
|  |               |                |                 |                               |

# STOCKHOLM

BY MARIO RUIZ, 2013



# design Nation

# punt

DIMENSIONS SIDEBOARD 180 cm DIMENSIONES APARADOR 180 cm

## STH351 Slim

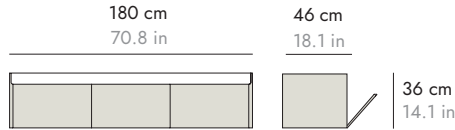
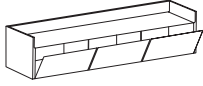

## STH353 Slim + Technic doors

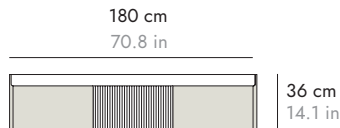
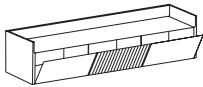

## STH354 Slim + Technic doors

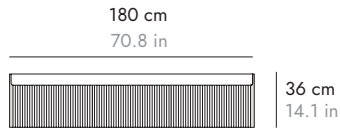
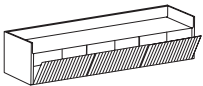

## STH301

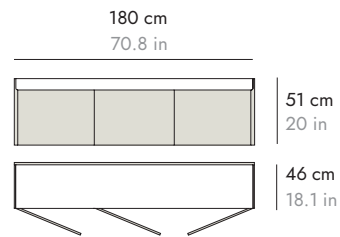
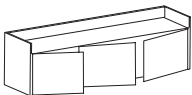

## STH302

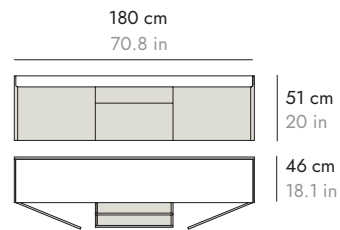
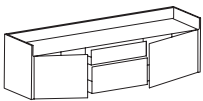

## STH303 Technic doors

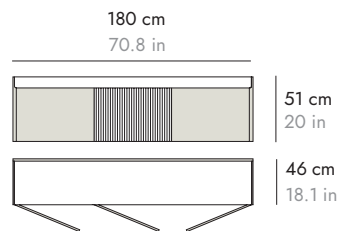
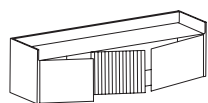

# STOCKHOLM

BY MARIO RUIZ, 2013



# design Nation

# punt

## DIMENSIONS SIDEBOARD 180 cm DIMENSIONES APARADOR 180 cm

### STH304 Technic doors

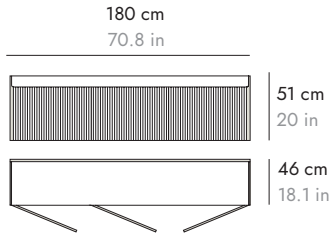
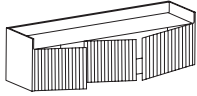

## DIMENSIONS CUPBOARD 180 cm DIMENSIONES ALACENA 180 cm

### STH334 Technic doors

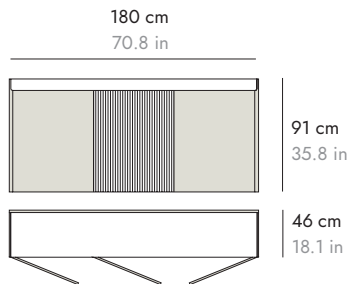
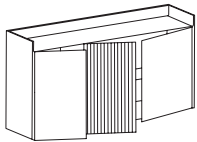

## METAL BASES ZÓCALOS

|  |                    |                    |                    |                                   |
|--|--------------------|--------------------|--------------------|-----------------------------------|
|  | H 6 cm - 2.3"      | H 17 cm - 6.7"     | H 29 cm - 11.4"    | WALL BRACKET<br>HERRAJE PARED<br> |
|  | 167 cm 65.7 in<br> | 175 cm 68.7 in<br> | 175 cm 68.7 in<br> |                                   |

## DIMENSIONS SIDEBOARD 238 cm DIMENSIONES APARADOR 238 cm

### STH451 Slim

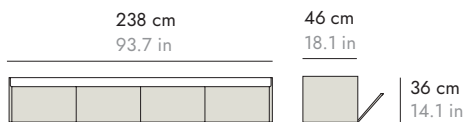
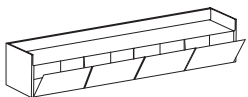

### STH453 Slim + Technic doors

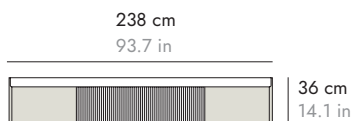
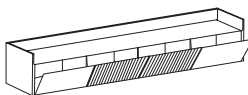

# STOCKHOLM

BY MARIO RUIZ, 2013



# design Nation

# punt

## DIMENSIONS SIDEBOARD 238 cm DIMENSIONES APARADOR 238 cm

**STH454** Slim + Technic doors

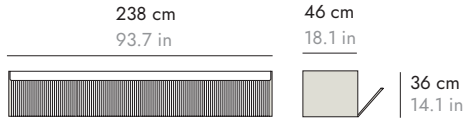
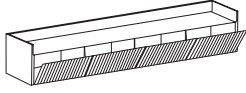

**STH401**

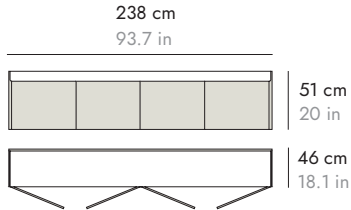
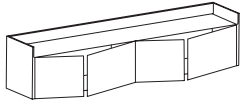

**STH402**

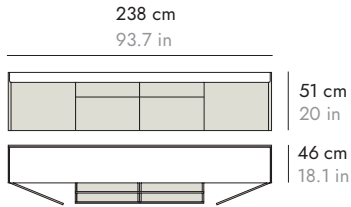
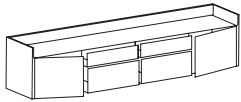

**STH403** Technic doors

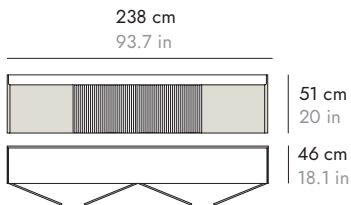
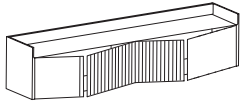

**STH404** Technic doors

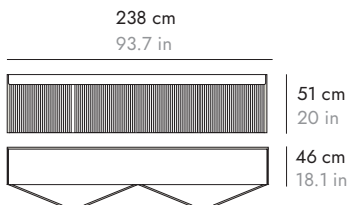
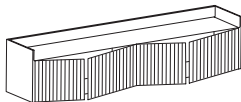



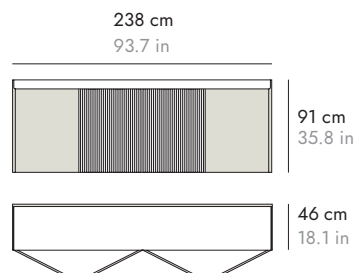
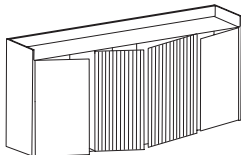

## DIMENSIONS CUPBOARD 238 cm DIMENSIONES ALACENA 238 cm

**STH434** Technic doors





## METAL BASES ZÓCALOS

|   |   |   |   |  |
|---|---|---|---|--|
|  | H 6 cm - 2.3"   | H 17 cm - 6.7"  | H 29 cm - 11.4"   | WALL BRACKET<br>HERRAJE PARED<br> |
|   |  |  |  |  |

## DIMENSIONS SIDEBOARD 296 cm DIMENSIONES APARADOR 296 cm

### STH553 Slim

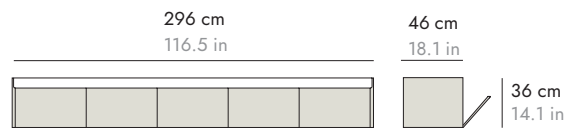
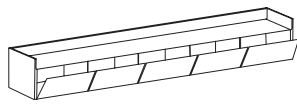

### STH556 Slim + Technic doors

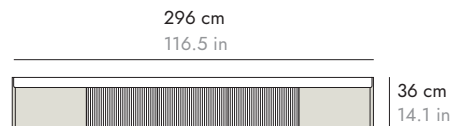
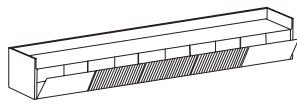

### STH557 Slim + Technic doors

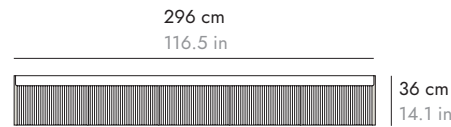
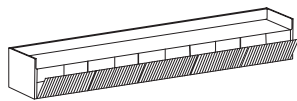

### STH503

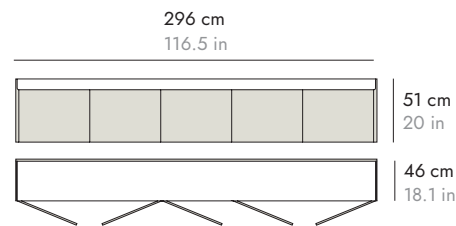
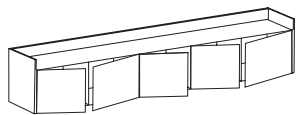

### STH504 Technic doors

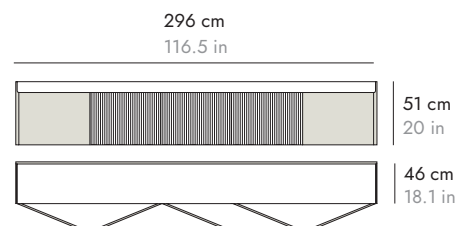
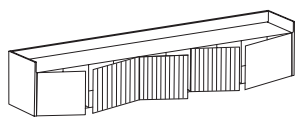



# STOCKHOLM

BY MARIO RUIZ, 2013



design Nation

punt

## DIMENSIONS SIDEBOARD 296 cm DIMENSIONES APARADOR 296 cm

STH507 Technic doors

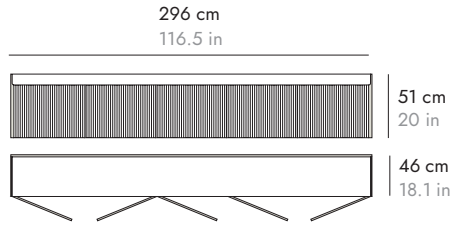
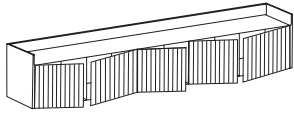

## METAL BASES ZÓCALOS

|  |               |                |                 |                                   |
|--|---------------|----------------|-----------------|-----------------------------------|
|  | H 6 cm - 2.3" | H 17 cm - 6.7" | H 29 cm - 11.4" | WALL BRACKET<br>HERRAJE PARED<br> |
|  |               |                |                 |                                   |

## DIMENSIONS CUPBOARD 93 cm DIMENSIONES ALACENAS 93 cm

STH011

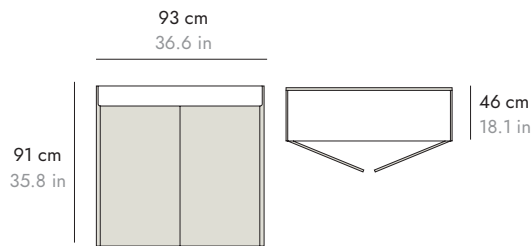
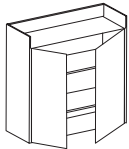

## DIMENSIONS CHEST OF DRAWERS 93 cm DIMENSIONES CÓMODA 93 cm

STH012

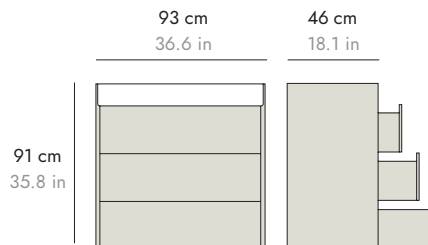
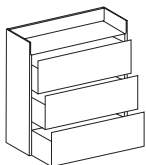

## METAL BASES ZÓCALOS

|  |               |                |                 |
|--|---------------|----------------|-----------------|
|  | H 6 cm - 2.3" | H 17 cm - 6.7" | H 29 cm - 11.4" |
|  |               |                |                 |

# STOCKHOLM

BY MARIO RUIZ, 2013



# design Nation

# *punt*

## DIMENSIONS DESKS DIMENSIONES ESCRITORIOS

---

### STH702



### STH712

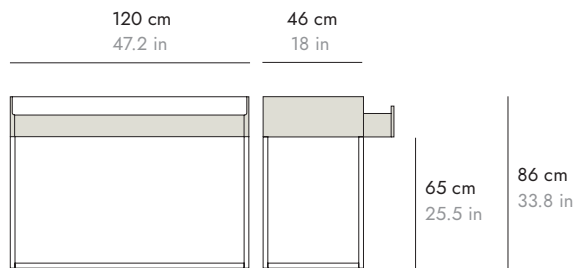
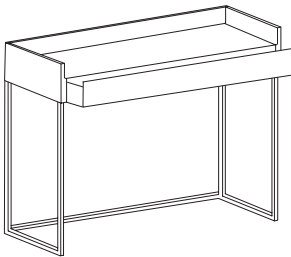

# STOCKHOLM

BY MARIO RUIZ, 2013



design Nation

*punt*

## CABLE MANAGEMENT PASACABLES

The Stockholm collection offers the possibility to order the sideboards without cable grommets or with cable grommets. Those with cable grommets will have a hinged cover for cable entry in the aluminium top and one cable grommet hole per door on the back. They also include a cover cap per hole.

La colección Stockholm ofrece la posibilidad de solicitar los aparadores sin pasacables o con pasacables. Aquellos con pasacables tendrán una tapa con bisagras para el paso de cables en el sobre de aluminio y en la trasera un agujero pasacables por puerta. Incluyen también un tapón embellecedor por agujero.



### Outside detail. Detalle exterior

Hinged flap on the aluminium top.

Tapa con bisagras en el sobre de aluminio.

### Internal detail. Detalle interior

Cable grommets per door in top and back.

Agujeros pasacables por puerta en tapa y trasera.

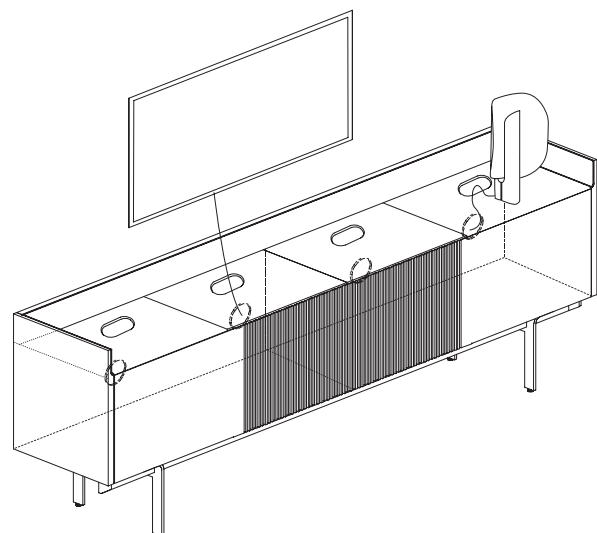
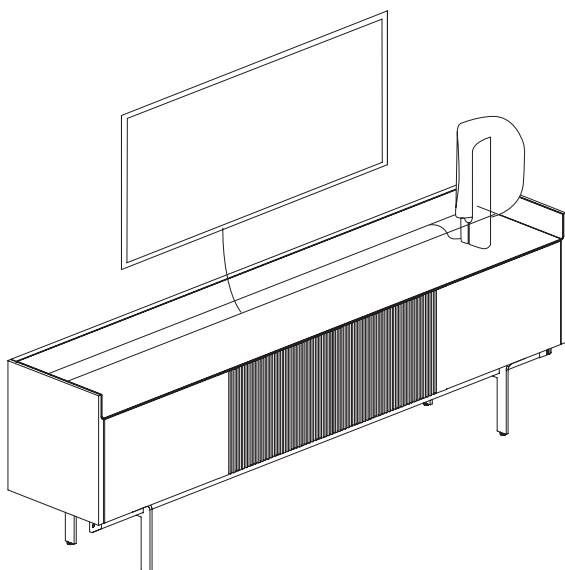

## TECHNICAL SPECIFICATIONS ESPECIFICACIONES TÉCNICAS

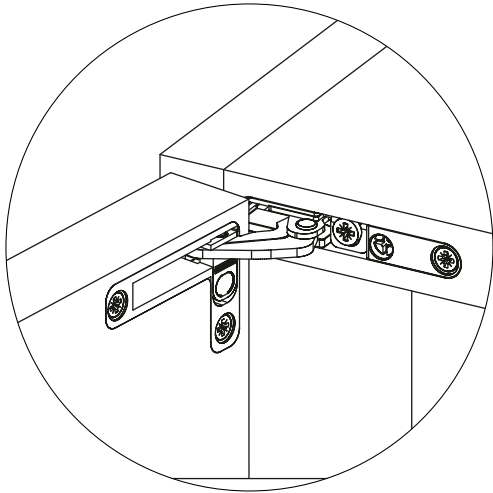

Invisible hinge fitting for side opening.  
Herraje de bisagra invisible para apertura lateral.

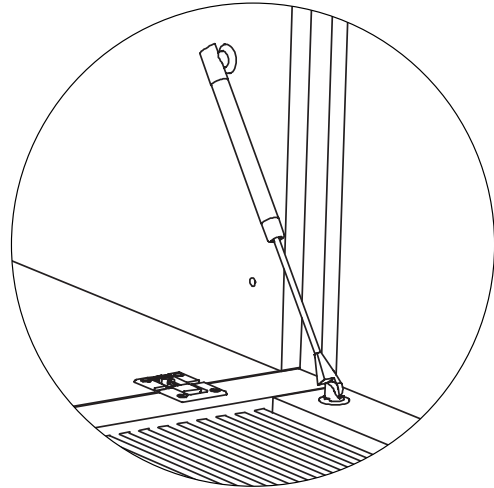

Downward opening system for SLIM sideboards.  
Sistema de apertura descendente para aparadores SLIM.

- Handleless doors with 105° opening.
- Puertas sin tiradores con apertura a 105°.

- Units with doors include height adjustable shelf.
- Los módulos con puertas incluyen estante regulable en altura.

- Drawers with full-extension runners.
- Cajones con guías de extracción total.

## ACCESSORIES STOCKHOLM COLLECTION ACCESORIOS COLECCIÓN STOCKHOLM

### ACC027

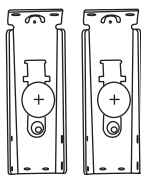

Fittings for hanging the modules on the wall.  
Please consult the number of units required for each composition.

Herrajes para fijar los módulos a pared.  
Consultar número de unidades necesarias para cada composición.

## MATERIALS

### Wood.

Interior and exterior modules in E1 MDF board and E1 particle board (low formaldehyde content) clad in oak or natural walnut with continuous mesh. Technic finish doors are solid wood slatted doors.

### Aluminum.

Top in anodized aluminum or smooth matte metal.

### Steel.

Textured thermo-lacquered steel plinths with adjustable feet.

## MATERIALES

### Madera.

Módulos interior y exterior en tablero de MDF E1 y tablero de partículas E1 (bajo contenido en formaldehído) aplacado en madera de roble o nogal natural con malla continua. Las puertas en acabado Technic son alistonadas en madera maciza.

### Aluminio.

Tapa de aluminio anodizado o metal liso mate.

### Acero.

Zócalos de acero termo-lacado texturizado con pies regulables.

## Units & doors Módulos y puertas

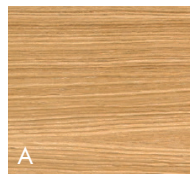

**A**  
SUPER MATT OAK  
ROBLE SÚPER MATE  
CHENE SUPERMATE  
SUPER MATT EICHE  
ROVERE OPACO



**C**  
WHITENED OAK  
ROBLE BLANQUEADO  
CHENE BLANCHI  
EICHE WEISS  
ROVERE SBIANCATO



**C**  
WALNUT STAINED OAK  
ROBLE TEÑIDO NOGAL  
CHENE TEINTÉ NOYER  
EICHE NUSSBAUM  
GEBEIZT  
ROYERE TINTO NOLE



**C**  
DARK GREY STAINED OAK  
ROBLE TEÑIDO GRIS  
CHENE TEINTE GRIS  
DUNKELGRAU GEBEIZTE  
EICHE  
ROVERE TINTO GRIGIO  
SCURO

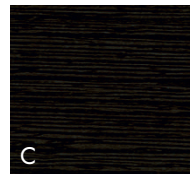

**C**  
EBONY STAINED OAK  
ROBLE TEÑIDO ÉBANO  
CHENE TEINTÉ ÉBÔNE  
EICHE GEBEIZT  
EBENHOLZ  
ROVERE TINTO ÉBANO



**B**  
SUPER MATT WALNUT  
NOGAL SÚPER MATE  
NOYER SUPER MATE  
SUPERMATT WALNUSS  
NOCE OPACO

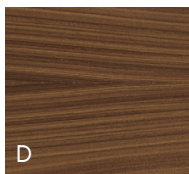

**D**  
WALNUT STAINED WALNUT  
NOGAL TEÑIDO NOGAL  
NOYER TEINTÉ NOYER  
WALNUSS GEBEIZT  
WALNUSS  
NOCE TINTO NOCE



**D**  
DARK STAINED WALNUT  
NOGAL TEÑIDO OSCURO  
NOYER TEINTÉ FONCÉ  
WALNUSS DUNKEL  
GEBEIZT  
NOCE TINTO SCURO

## Top Tapa



**GOLD**  
ORO  
DORÉ  
GOLD  
ORO

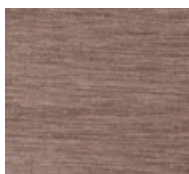

**PALE ROSE**  
ROSA PÁLIDO  
PALE ROSE  
PALE ROSE  
PALE ROSE

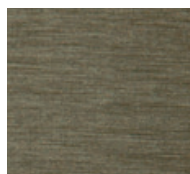

**BRONZE**  
BRONCE  
BRONZE  
BRONZE  
BRONZE



**CHOCOLATE**  
CHOCOLATE  
CHOCOLAT  
SCHOKOLADE  
CIOCCOLATO

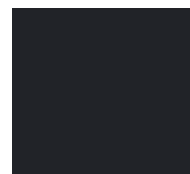

**BLACK**  
NEGRO  
NOIR  
SCHWARZ  
NERO

## Metal base Zócalo

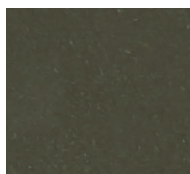

**BRONZE**  
BRONCE  
BRONZE  
BRONZE  
BRONZE

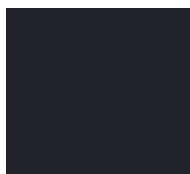

**BLACK**  
NEGRO  
NOIR  
SCHWARZ  
NERO