



## SUSSEX

TECHNICAL INFORMATION SHEET

# SUSSEX

BY TERENCE WOODGATE, 2000



design Nation

*punt*

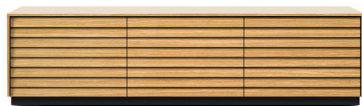

## PRODUCT TYPE

Sideboard

The Sussex modular system is inspired by the characteristic wood panel cladding of the barns of southern England. These repeated horizontal slats conceal the composition of the modules and serve as handles for doors or drawers. The collection includes different base options, as it can rest on a plinth, on adjustable feet or hung on the wall. Door elements include height-adjustable shelf.

## TIPOLOGÍA DE PRODUCTO

Aparador

El sistema modular Sussex se inspira en los característicos revestimientos con tableros de madera de los graneros del sur de Inglaterra. Estos listones horizontales repetidos ocultan la composición de los módulos y sirven como tiradores para puertas o cajones. La colección incluye diferentes opciones de base, ya que puede descansar sobre un zócalo, sobre pies regulables o colgado a la pared. Los elementos de puertas incluyen estante regulable en altura.

## DETAILS. DETALLES



## BED SIDE TABLES MESITAS DE NOCHE

### SSX141

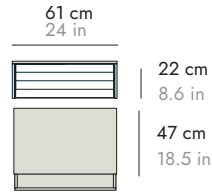
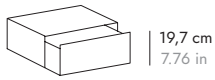

### SSX142

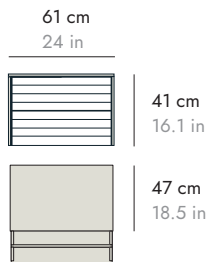
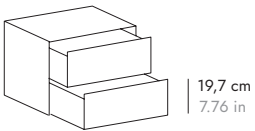

## METAL BASES ZÓCALOS

	H 6 cm - 2.3"	H 17 cm - 6.7"	H 29 cm - 11.4"	WALL BRACKET HERRAJE PARED 
	53.5 cm 21 in 	58 cm 22.9 in 	58 cm 22.9 in 	

## SIDEBOARDS 119 cm APARADORES 119 cm

### SSX201

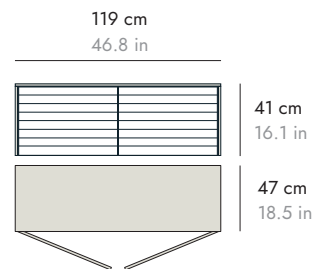
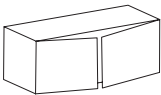

### SSX202

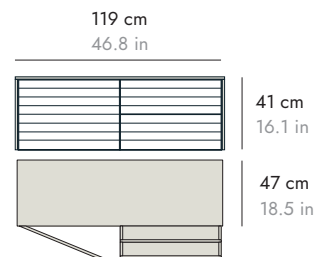
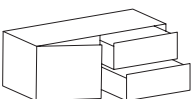

## SIDEBOARDS 119 cm APARADORES 119 cm

### SSX231

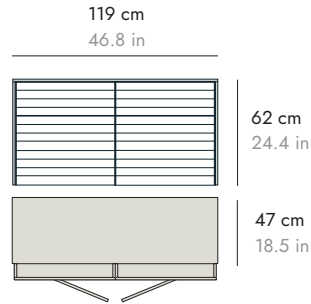
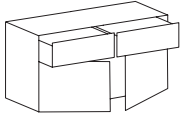

## METAL BASES ZÓCALOS

	H 6 cm - 2.3"	H 17 cm - 6.7"	H 29 cm - 11.4"	<b>WALL BRACKET</b> HERRAJE PARED 
	 110 cm 43.3 in	 116 cm 45.6 in	 116 cm 45.6 in	

## SIDEBOARDS 178 cm APARADORES 178 cm

### SSX341 Slim

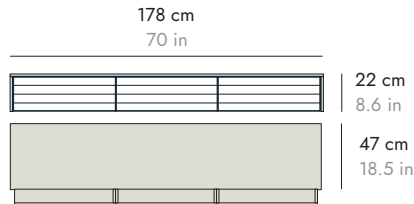
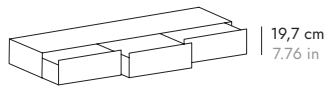

### SSX301

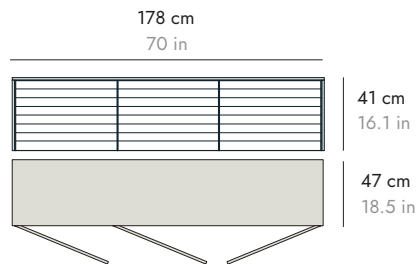
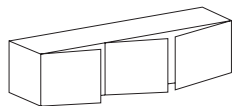

### SSX302

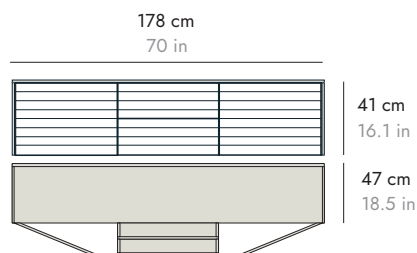
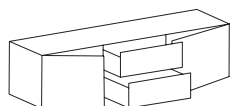

## SIDEBOARDS 178 cm APARADORES 178 cm

### SSX331

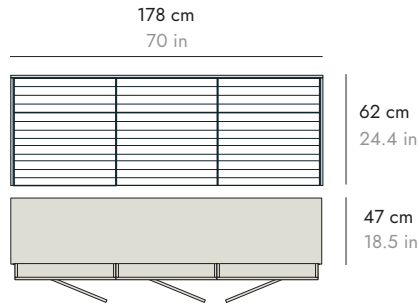
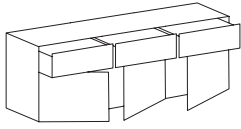

## METAL BASES ZÓCALOS

	<b>H 6 cm - 2.3"</b>	<b>H 17 cm - 6.7"</b>	<b>H 29 cm - 11.4"</b>	<b>WALL BRACKET</b> <b>HERRAJE PARED</b> 
	167 cm 65.7 in 	175 cm 68.7 in 	175 cm 68.7 in 	

## SIDEBOARDS 236 cm APARADORES 236 cm

### SSX441 Slim

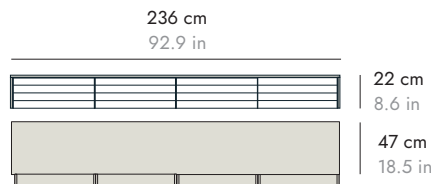
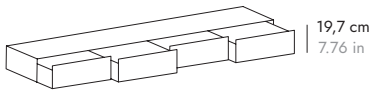

### SSX401

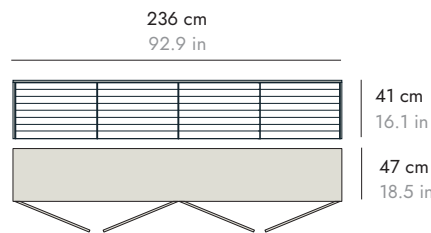
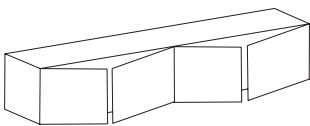

### SSX402

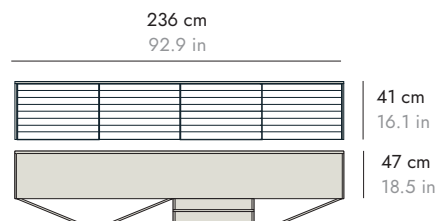
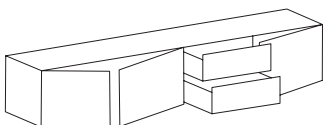

**SIDEBOARDS 119 cm APARADORES 119 cm**

**SSX431**

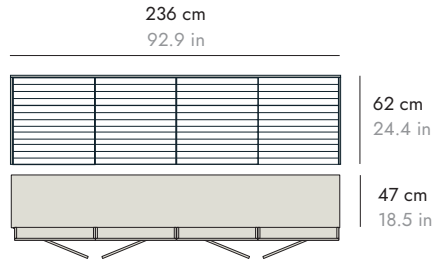
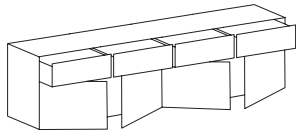

**METAL BASES ZÓCALOS**

	H 6 cm - 2.3"	H 17 cm - 6.7"	H 29 cm - 11.4"	WALL BRACKET HERRAJE PARED
	233 cm 91.7 in 	233 cm 91.7 in 	233 cm 91.7 in 	

**ACCESSORIES ACCESORIOS**

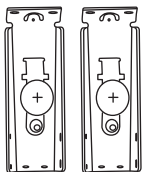

Fittings for hanging the modules on the wall.  
Please consult the number of units required for each composition.

Herrajes para colgar los módulos a pared.  
Consultar número de unidades necesarias para cada composición.

## MATERIALS

### Modules.

E1 particle board (low formaldehyde content) with oak or natural walnut veneer.

### Doors.

Doors in E1 particle board (low formaldehyde content) veneered in oak or natural walnut. 94° opening and drawers with absorption closing.

### Plinths.

Textured thermo-lacquered steel base with adjustable feet.

## MATERIALES

### Módulos.

Tablero de partículas E1 (bajo contenido en formaldehído) aplacado en madera de roble o nogal natural.

### Puertas.

Puertas de tablero de partículas E1 (bajo contenido en formaldehído) aplacado en madera de roble o nogal natural. Apertura de 94° y cajones con cierre por absorción.

### Zócalos.

Base de acero termo-lacado texturizado con pies regulables.

## Units Módulos



**A**  
**SUPER MATT OAK**  
 ROBLE SÚPER MATE  
 CHENE SUPERMATE  
 SUPER MATT EICHE  
 ROVERE OPACO



**C**  
**WHITENED OAK**  
 ROBLE BLANQUEADO  
 CHENE BLANCHI  
 EICHE WEISS  
 ROVERE SBIANCATO



**C**  
**WALNUT STAINED OAK**  
 ROBLE TEÑIDO NOGAL  
 CHENE TEINTÉ NOYER  
 EICHE NUSSBAUM  
 GEBEIZT  
 ROYERE TINTO NOLE



**C**  
**DARK GREY STAINED OAK**  
 ROBLE TEÑIDO GRIS  
 CHENE TEINTE GRIS  
 DUNKELGRAU GEBEIZTE  
 EICHE  
 ROVERE TINTO GRIGIO  
 SCURO

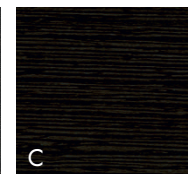

**C**  
**EBONY STAINED OAK**  
 ROBLE TEÑIDO ÉBANO  
 CHENE TEINTÉ ÉBÔNE  
 EICHE GEBEIZT  
 EBENHOLZ  
 ROVERE TINTO ÈBANO



**B**  
**SUPER MATT WALNUT**  
 NOGAL SÚPER MATE  
 NOYER SUPER MATE  
 SUPERMATT WALNUSS  
 NOCE OPACO

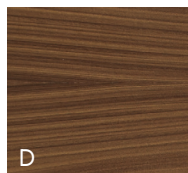

**D**  
**WALNUT STAINED WALNUT**  
 NOGAL TEÑIDO NOGAL  
 NOYER TEINTÉ NOYER  
 WALNUSS GEBEIZT  
 WALNUSS  
 NOCE TINTO NOCE



**D**  
**DARK STAINED WALNUT**  
 NOGAL TEÑIDO OSCURO  
 NOYER TEINTÉ FONCÉ  
 WALNUSS DUNKEL  
 GEBEIZT  
 NOCE TINTO SCURO

## Metal base Zócalo

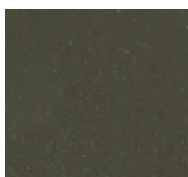

**BRONZE EPOXI**  
 BRONCE EPOXI  
 BRONZE EPOXI  
 BRONZE EPOXI  
 BRONZE EPOXI

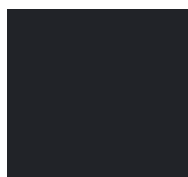

**BLACK EPOXI**  
 NEGRO EPOXI  
 NOIR EPOXI  
 SCHWARZ EPOXI  
 NERO EPOXI